

TAURUS COLOR

CZ TAURUS COLOR – harmonie bez limitů

Vysoce slinuté neglazované jednobarevné dlaždice série Taurus COLOR ve formátech 5 x 5 cm, 10 x 10 cm, 20 x 20 cm, 30 x 30 cm a 60 x 60 cm barevně harmonizují s nočními barvami sérií ColorONE a ColorTWO. Barevná synergie jednotlivých sérií přispívá k vytvoření esteticky zajímavého prostoru při zachování vysokých nároků na užité vlastnosti. Důležitou součástí nabídky jsou funkční doplňky pro standardní i náročnější řešení.

EN TAURUS COLOR – harmony without limits

Fully vitrified unglazed uni-coloured tiles of the Taurus COLOR in the formats 5 x 5 cm, 10 x 10 cm, 20 x 20 cm, 30 x 30 cm and 60 x 60 cm harmonise with the night colours of series ColorONE and ColorTWO. The colour synergy of individual series contributes to creation of an interesting space while the high demands for utility properties are maintained. An important part of the offer includes functional special pieces for both standard and demanding solutions.

PL TAURUS COLOR – harmonia bez ograniczeń

Wysokospiekane nieszkliwione jednobarwne płytki gresowe serii Taurus COLOR w formatach 5 x 5 cm, 10 x 10 cm, 20 x 20 cm, 30 x 30 cm i 60 x 60 cm, kolorystycznie harmonizują z nocnymi barwami serii ColorONE i ColorTWO. Barwna synergie poszczególnych serii pozwala wytworzyć estetyczną, ciekawą przestrzeń przy zachowaniu wysokich walorów użytkowych. Ważnym elementem serii są kształtki o różnej funkcjonalności.

RUS TAURUS COLOR – гармония без ограничений

Высокоспекаемая неглазуванная одноцветная плитка серии Taurus COLOR в формате 5 x 5 см, 10 x 10 см, 20 x 20 см, 30 x 30 см и 60 x 60 см, по цвету гармонирующая с холодными цветами серии ColorONE и ColorTWO. Цветовое решение серии способствует созданию эстетически интересного пространства при сохранении высоких требований к полезным свойствам. Важной составной частью предложения являются функциональные аксессуары для стандартных и более сложных решений.

HU TAURUS COLOR – határok nélküli harmónia

A Taurus COLOR program homogén színű mázatlan gres termékei 5 x 5 cm, 10 x 10 cm, 20 x 20 cm, 30 x 30 cm és 60 x 60 cm-es méretben összhangban van a ColorONE és ColorTWO termékcsalád színeivel. A rendelkezésre álló színválaszték segítségével lehetőségünk van teljesen egyedi stílusú burkolatot létrehozni anélkül, hogy le kellene mondanunk a minőség iránti igényünkről. A program fontos részét képezi a különböző kiegészítő elemek választéka.

ES TAURUS COLOR - armonía sin límites

Baldosas sin esmaltar altamente vitrificadas de la serie Taurus COLOR en formatos de 5 x 5 cm, 10 x 10 cm, 20 x 20 cm, 30 x 30 cm y 60 x 60 cm coinciden con los colores nocturnos de las series ColorONE y ColorTWO. Estas sinergias entre las series y sus colores permiten crear espacios con alto valor estético manteniendo altas exigencias técnicas y propiedades para zonas públicas. Una parte importante de la oferta son accesorios técnicos y funcionales para ofrecer soluciones estándares o las más exigentes.

TAURUS COLOR



EN 14411:2016, annex G Bia UGL
STO ě. 030-049913
STO ě. 030-049916



Wyródek
Product

Povrch
Surface

Protiskliznost
Slip resistance
koeficient tření - za sucha



cm	mm	W	Wyródek Product	Povrch Surface	Protiskliznost Slip resistance koeficient tření - za sucha	19 Black	07 Dark Grey	06 Light Grey	11 Extra White	10 Super White	30 Mocca	
5x5	48x48x9	R	mozaika set 30x30 cm	mosaic sheet 30x30 cm	S	R10/B $\mu \geq 0,7$	TDM06019 68 set	TDM06007 68 set	TDM06006 68 set	TDM06011* 68 set	TDM06010 68 set	TDM06030 68 set
10x10	98x98x9		dlaždice floor tile		S	R10/B $\mu \geq 0,7$	TAA12019 88 m ²	TAA12007* 86 m ²	TAA12006 86 m ²	TAA12011* 92 m ²	TAA12010 86 m ²	TAA12030* 86 m ²
20x20	198x198x9		dlaždice floor tile		S	R10/A $\mu \geq 0,6$	TAA26019 82 m ²	TAA26007 80 m ²	TAA26006 80 m ²	TAA26010 80 m ²	TAA26030 80 m ²	
30x30	298x298x9		dlaždice floor tile		S	R9/A $\mu \geq 0,6$	TAA35019 82 m ²	TAA35007 78 m ²	TAA35006 78 m ²	TAA35011* 86 m ²	TAA35010 78 m ²	TAA35030 78 m ²
60x60	598x598x10	R	dlaždice floor tile		S	R9/A $\mu \geq 0,6$	TAA61019 88 m ²	TAA61007 88 m ²	TAA61006 88 m ²	TAA61010 88 m ²	TAA61030 88 m ²	
30x30	298x298x9		schodovka step tile		S	R9/A $\mu \geq 0,6$	TCP35019* 46 ks	TCP35007* 46 ks	TCP35006* 46 ks	TCP35011* 48 ks	TCP35010* 46 ks	TCP35030* 46 ks
60x9,5	598x95x10	R	sokl skirting plinth		S		TSAS4019 52 ks	TSAS4007 52 ks	TSAS4006 52 ks	TSAS4010 52 ks	TSAS4030 52 ks	
30x8	298x80x9		sokl skirting plinth		S		TSAJB019 28 ks	TSAJB007* 28 ks	TSAJB006* 28 ks	TSAJB011* 28 ks	TSAJB010 28 ks	TSAJB030* 28 ks
20x9	198x90x9		sokl s požílábkem cove skirting		S		TSPEM019* 32 ks	TSPEM007* 32 ks	TSPEM006* 32 ks	TSPEM010* 32 ks	TSPEM030* 32 ks	
2,3x9	23x90x10		sokl vnitřní roh cove skirting inside corner		S		TSIRB019* 48 ks	TSIRB007* 48 ks	TSIRB006* 48 ks	TSIRB010* 48 ks	TSIRB030* 48 ks	
2,3x9	23x90x7		sokl vnější roh cove skirting outside corner		S		TSERB019* 48 ks	TSERB007* 48 ks	TSERB006* 48 ks	TSERB010* 48 ks	TSERB030* 48 ks	
30x8	298x80x9		sokl s požílábkem cove skirting		S		TSPJB019* 34 ks	TSPJB007* 34 ks	TSPJB006* 34 ks	TSPJB010* 34 ks	TSPJB030* 34 ks	
2,3x8	23x80x10		sokl vnitřní roh cove skirting inside corner		S		TSIRH019* 48 ks	TSIRH007* 48 ks	TSIRH006* 48 ks	TSIRH010* 48 ks	TSIRH030* 48 ks	
2,3x8	23x80x7		sokl vnější roh cove skirting outside corner		S		TSERH019* 48 ks	TSERH007* 48 ks	TSERH006* 48 ks	TSERH010* 48 ks	TSERH030* 48 ks	
10x10	98x98x8		bezbariérová tvarovka rohová	shower piece corner	SB	R10/B $\mu \geq 0,7$	TTR12019 54 ks	TTR12007 54 ks	TTR12006 54 ks	TTR12010 54 ks	TTR12030 54 ks	
10x10	98x98x8		bezbariérová tvarovka průběžná	shower piece continuous	SB	R10/B $\mu \geq 0,7$	TTP12019 54 ks	TTP12007 54 ks	TTP12006 54 ks	TTP12010 54 ks	TTP12030 54 ks	

* Výroba na objednávku | Production by order | Produkcja na zamówienie | Производство под заказ | Gyártás rendelésre | Producción bajo demanda

S - Standardní povrch | Standard surface | Standartowa powierzchnia | Стандартная поверхность | Sima felület | Superficie estándar

SB - Hladký protiskluzný povrch | Smooth slip-resistant surface | Przeciwpślizgowa powierzchnia bez reliefu (szorstka) | Гладкая с противоскользящей поверхностью | Sima csúszásgátló felülettel | Superficie antideslizante liso

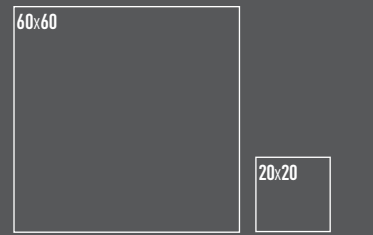

TAA61019 R9 A $\mu \geq 0,6$ R TAA26019 R10 A $\mu \geq 0,6$

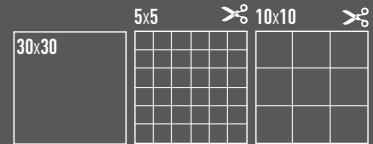

TAA35019 R9 A $\mu \geq 0,6$ TDM06019 R10 B $\mu \geq 0,7$ R TAA12019 R10 B $\mu \geq 0,7$



19 S Black

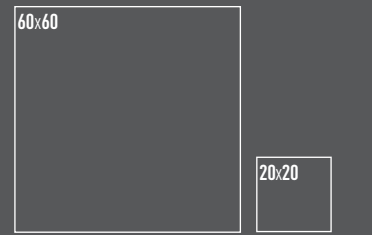

TAA61007 R9 A $\mu \geq 0,6$ R TAA26007 R10 A $\mu \geq 0,6$

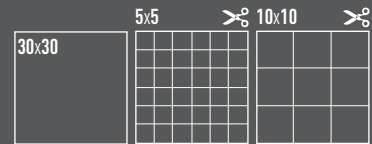

TAA35007 R9 A $\mu \geq 0,6$ TDM06007 R10 B $\mu \geq 0,7$ R TAA12007 R10 B $\mu \geq 0,7$



07 S Dark Grey



TAA61006 R9 A $\mu \geq 0,6$ R TAA26006 R10 A $\mu \geq 0,6$

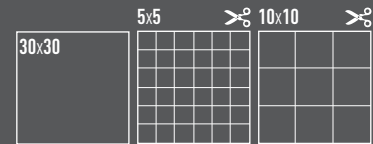

TAA35006 R9 A $\mu \geq 0,6$ TDM06006 R10 B $\mu \geq 0,7$ R TAA12006 R10 B $\mu \geq 0,7$

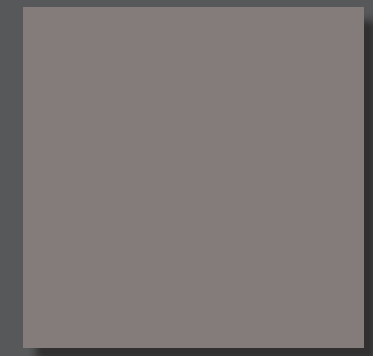

06 S Light Grey



TAA61010 R9 A $\mu \geq 0,6$ R TAA26010 R10 A $\mu \geq 0,6$

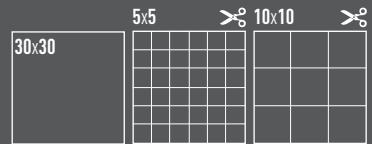

TAA35011 R9 A $\mu \geq 0,6$ TDM06011 R10 B $\mu \geq 0,7$ R TAA12011 R10 B $\mu \geq 0,7$

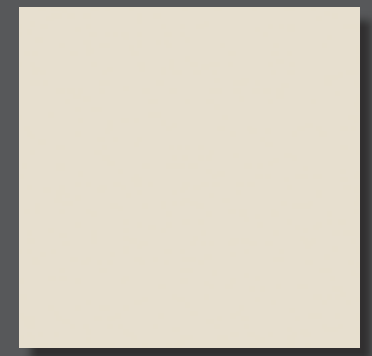

11 S Extra White



TAA61010 R9 A $\mu \geq 0,6$ R TAA26010 R10 A $\mu \geq 0,6$

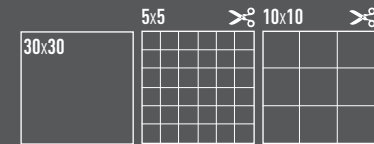

TAA35010 R9 A $\mu \geq 0,6$ TDM06010 R10 B $\mu \geq 0,7$ R TAA12010 R10 B $\mu \geq 0,7$



10 S Super White



TAA61030 R9 A $\mu \geq 0,6$ R TAA26030 R10 A $\mu \geq 0,6$

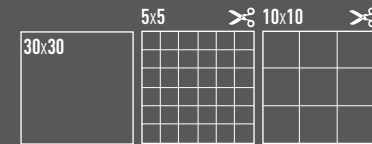

TAA35030 R9 A $\mu \geq 0,6$ TDM06030 R10 B $\mu \geq 0,7$ R TAA12030 R10 B $\mu \geq 0,7$

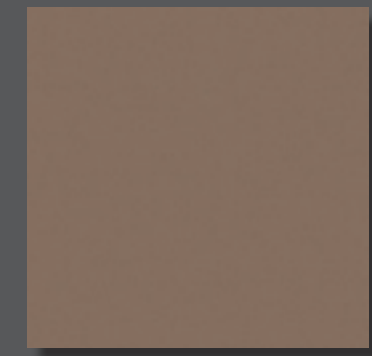

30 S Mocca





schodovka | **TCP35...** | 298x298x9 mm
step tile | **TCP35...** | 298x298x9 mm

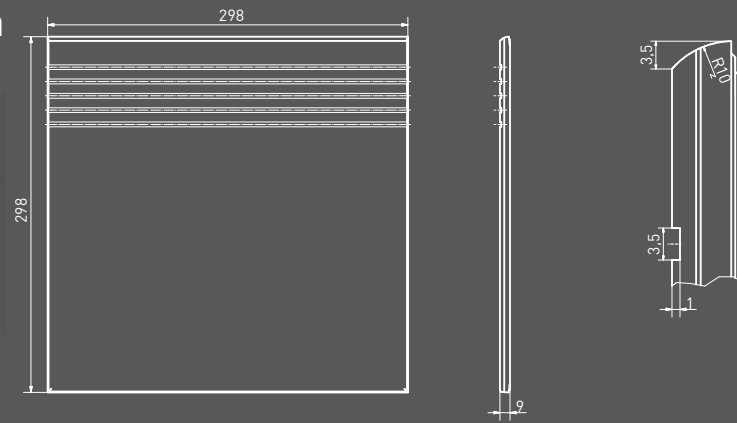
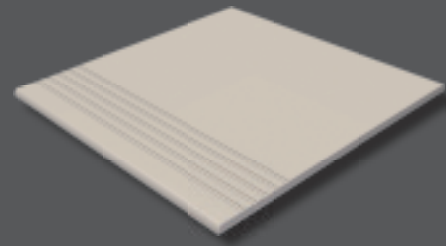

sokl | **TSAS4...** | 598x95x10 mm
skirting plinth | **TSAS4...** | 598x95x10 mm

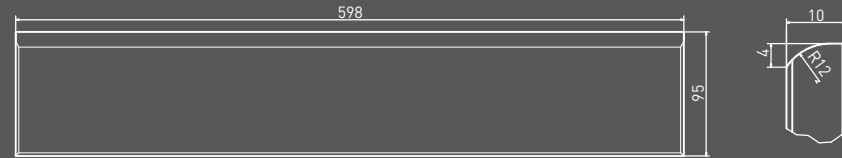

sokl | **TSAJB...** | 298x80x9 mm
skirting plinth | **TSAJB...** | 298x80x9 mm



sokl s požlábkem | **TSPEM...** | 198x90x9 mm
cove skirting | **TSPEM...** | 198x90x9 mm

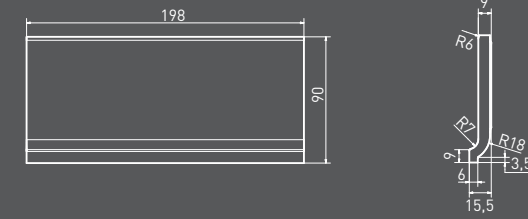
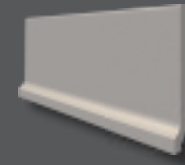

sokl vnitřní roh | **TSIRB...** | 23x90x10 mm
cove skirting inside corner | **TSIRB...** | 23x90x10 mm

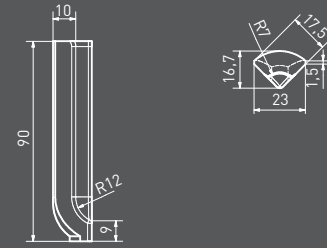

sokl vnější roh | **TSERB...** | 23x90x7 mm
cove skirting outside corner | **TSERB...** | 23x90x7 mm

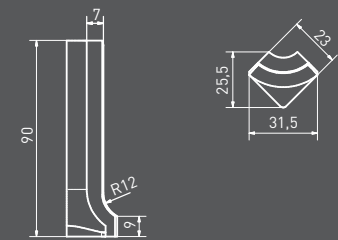

sokl s požlábkem | **TSPJB...** | 298x80x9 mm
cove skirting | **TSPJB...** | 298x80x9 mm

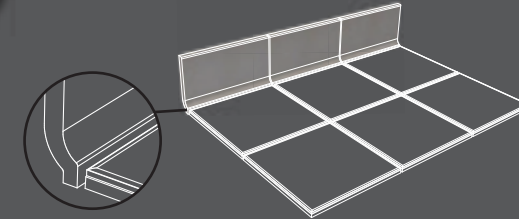

sokl vnitřní roh | **TSIRH...** | 23x80x10 mm
cove skirting inside corner | **TSIRH...** | 23x80x10 mm

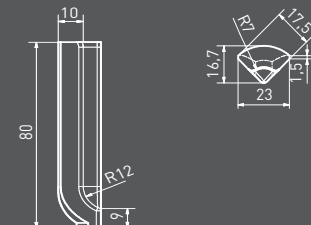

sokl vnější roh | **TSERH...** | 23x80x7 mm
cove skirting outside corner | **TSERH...** | 23x80x7 mm

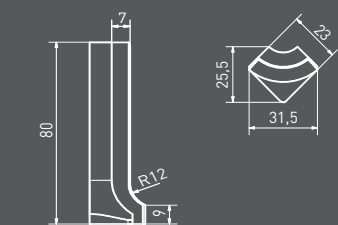



bezbariérová tvarovka rohová | **TTR12...** | 98x98x8 mm
shower piece - corner | **TTR12...** | 98x98x8 mm

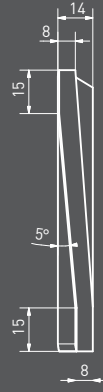
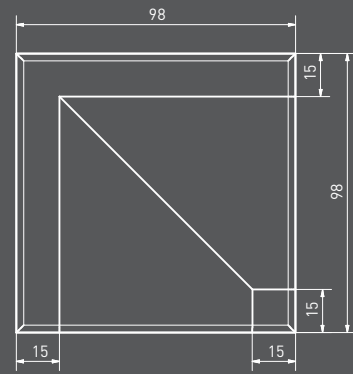

bezbariérová tvarovka průběžná | **TTP12...** | 98x98x8 mm
shower piece - continuous | **TTP12...** | 98x98x8 mm

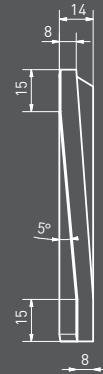
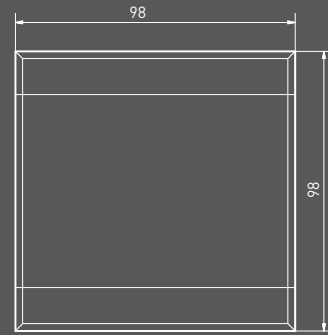
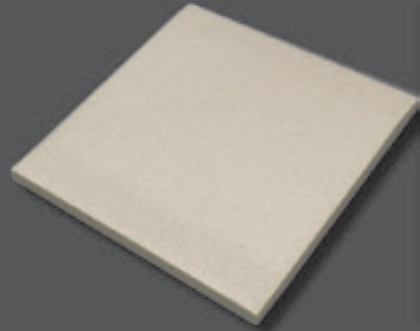

Logistická data | Logistic information

cm	mm	Výrobek Product	EN	ks/m ²	ks/m ²	m ²	m ²	kg	kg/m ²	brutto kg	
5x5	48x48x9	mozaika set 30x30 cm mosaic sheet 30x30 cm	STO č. 030 - 049913	3	11	0,27	-	-	5,2	19,2	-
10x10	98x98x9	dlaždice floor tile	EN 14411:2016, annex G Bla UGL	11	11	1,00	56	56,00	19,2	19,2	1 100
20x20	198x198x9	dlaždice floor tile	EN 14411:2016, annex G Bla UGL	25	25	1,00	57	57,00	19,2	19,2	1 120
30x30	298x298x9	dlaždice floor tile	EN 14411:2016, annex G Bla UGL	12	11	1,09	48	52,32	21,0	19,2	1 033
60x60	598x598x10	dlaždice floor tile	EN 14411:2016, annex G Bla UGL	3	2,8	1,08	32	34,56	25,0	23,1	824
30x30	298x298x9	schodovka step tile	STO č. 030 - 049916	11	11	1,00	52	52,00	19,2	19,2	1 024
60x9,5	598x95x10	sokl skirting plinth	STO č. 030 - 049916	13	17,5	0,74	-	-	15,9	21,5	-
30x8	298x80x9	sokl skirting plinth	STO č. 030 - 049916	21	42	0,50	77	38,50	9,5	19,0	762
20x9	198x90x9	sokl s pozábkem cove skirting	STO č. 030 - 049916	22	55	0,40	-	-	7,7	19,2	-
2,3x9	23x90x10	sokl vnitřní roh cove skirting inside corner	STO č. 030 - 049916	-	-	-	-	-	-	-	-
2,3x9	23x90x7	sokl vnější roh cove skirting outside corner	STO č. 030 - 049916	-	-	-	-	-	-	-	-
30x8	298x80x9	sokl s pozábkem cove skirting	STO č. 030 - 049916	21	42	0,50	72	36,00	9,5	19,0	709
2,3x8	23x80x10	sokl vnitřní roh cove skirting inside corner	STO č. 030 - 049916	-	-	-	-	-	-	-	-
2,3x8	23x80x7	sokl vnější roh cove skirting outside corner	STO č. 030 - 049916	-	-	-	-	-	-	-	-
10x10	98x98x9	bezbariérová tvarovka rohová shower piece - corner	STO č. 030 - 049916	16	100	0,16	-	-	2,2	13,0	-
10x10	98x98x9	bezbariérová tvarovka průběžná shower piece - continuous	STO č. 030 - 049916	16	100	0,16	-	-	2,2	13,0	-